

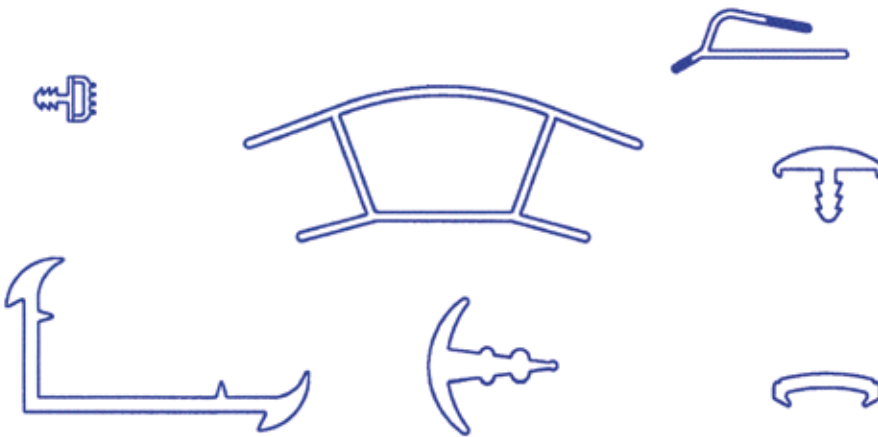

Technical Profiles

of thermoplastics



Estorfer Kunststoffbetrieb GmbH

Zum Finkenberg 12
D-31629 ESTORF
Telefon: +49 5025 9707-0
Telefax: +49 5025 9707-69
E-mail: info@estorfer.de
www.estorfer.de

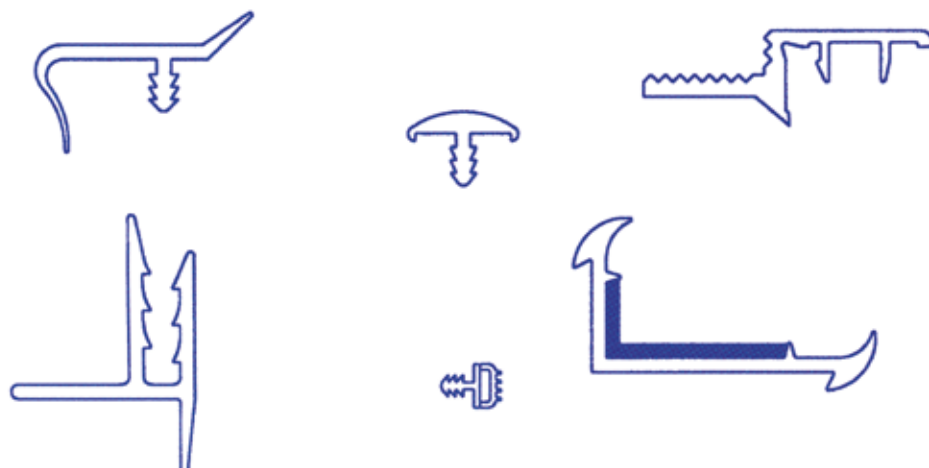

Estorfer Kunststoffbetrieb GmbH

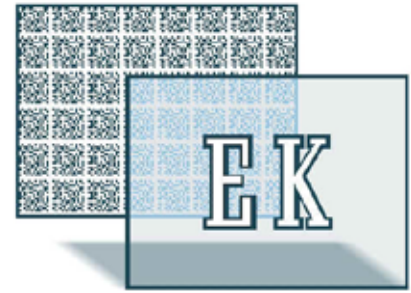

Estorfer Kunststoffbetrieb GmbH manufactures numerous special profiles that often form a key component within the final product. Our profiles meet the requirements placed on criteria, such as hardness, resistance to wear, design and durability.

Our specialities include:

- **Co-extruded profiles in rigid/plasticized PVC, including multicolored profiles**
- **Coating in butyl (rubber) and doubled-sided self-adhesive tapes**
- **Form-extruded profiles with raised, moulded surface**
- **Decorative coatings, currently encompassing some 100 different wood effects and approx. 10 metal decors**
- **Make-up to specification (cut to lengths, punched, drilled, welded, printed)**

Predominantly made from PVC, we manufacture profiles of all types to sample or drawing.

On request, we can also supply relevant quantities of profiles in other thermoplastic materials, such as PE, PS or TPE.

Partnership begins with a jointly defined design and development geared to the specific application. We are ideally equipped for the subsequent process of producing the special profile you require. Our own tool and jig shop, our own laboratory and our expertise gathered from four decades provide the basis for finding the right answer to your requirements.

At Estorfer Kunststoffbetrieb GmbH, we can provide you with everything on a one-stop-shop basis from consultancy right through to shipment of the finished product. This is also why we have been a partner to many segments of industry for 50 Years.

Contact our specialized consultants and we will be pleased to give you a quotation free of charge and with no obligation. All we need is a drawing, a dimensioned hand-drawn sketch or a sample. It would also be useful to know the intended purpose and your annual requirement.

Please note that we use personal data in accordance with DSGVO Art. 6 at the same time refer to Art. 7 para. 3, 15 and 17 GDPR. For general privacy policy see also www.estorfer.de

Estorfer Kunststoffbetrieb GmbH



**Lieferung in folgende Länder nur über unsere Auslandsvertretungen:
Please contact our business partners for deliveries to the following countries:**

Frankreich

Société DECMO
400, Rue Leon Gambetta
F-59044 Lille-Cedex
Tel.: +0328380840
Fax: +0328380850
E-mail: decmo@decmo.fr
www.decmo.com

Großbritannien

Scan-Térier Ltd.
30 The Metro Centre
Tolpits Lane, Watford
GB Herts. WD 18 9XG
Tel.: +0 19 23 / 80 03 53
Fax: +0 19 23 / 22 03 58
www.scan-terieur.com

Italien/Spanien

Dimatec S.P.A.
Via Galileo Galilei 7
I-22070 Guanzate (Co)
Tel.: +031.352.90.61
Fax: +031.352.90.97
E-mail: dimatec@dimatec.it
www.dimatec.it

Japan

Carac Industry CO. Ltd.
1-4-2 Heiwadei Nerima ku
Tokyo 179
732 Japan
Tel.: +03 (3931) 0220
Fax: +03 (3931) 0706
E-mail: okayama@carac.co.jp
www.carac.co.jp

Niederlande

JAC. VAN 't HART NEDERLAND B.V.
Dorp 92
3415 PH Polsbroek
Tel.: +31 (0) 182 308080
Fax: +31 (0) 182 309787
E-mail: info@hartnl.com
www.hartnl.eu

Sealings for caravans with mastic

A specially developed process allows us to apply the butyl sealant in any cross section to different profiles.

From renowned German manufactures, the butyl rubber we use is free of fillers and solvent, and therefore does not harden (unlike silicone sealants). Available in light-grey, dark-grey and white.

As one area of application, the product is used for sealing caravan- and mobil-shop bodies. For 35 years now we have been manufacturing edge seals with butyl-sealant that effectively reliably prevent the penetration of moisture at junction between wall and roof section.

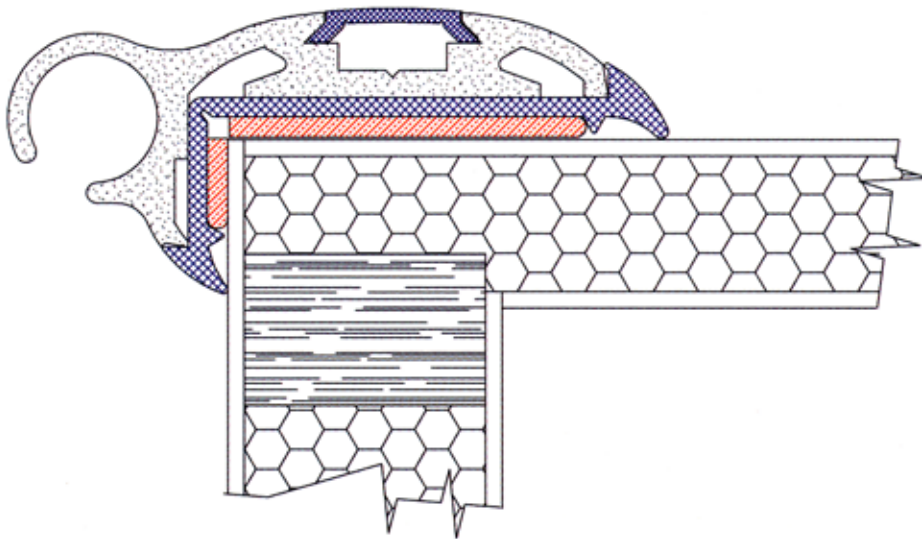

Other applications for this sealing systems include waterproofing on buildings (e.g. at junction between balconies, glass-roofs and other structures). Butyl never hardens, so it provides a permanent seal that is guaranteed to last for decades. We will pleased to help you with your particular requirement.

Sealing - profiles with mastic

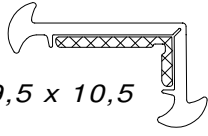
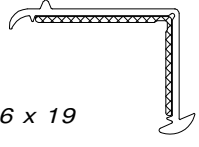
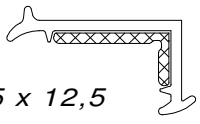
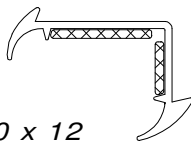
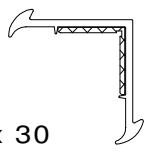
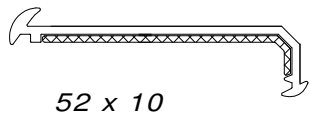
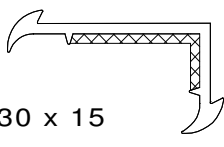
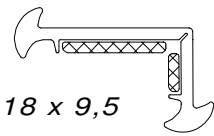
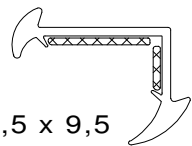
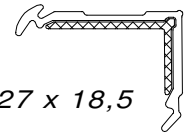
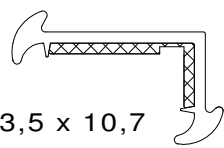
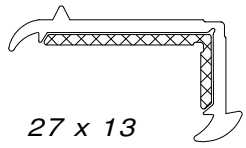
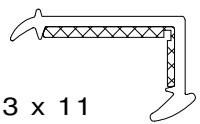
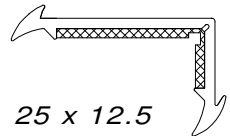
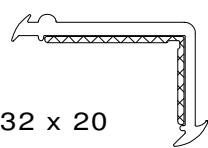
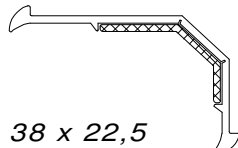
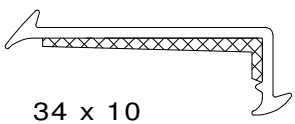
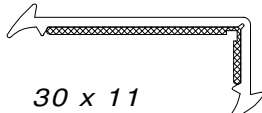
Profile no.	Drawing	Profile no.	Drawing
K 019	 19,5 x 10,5	K 074	 26 x 19
K 050	 25 x 12,5	K 077	 20 x 12
K 056	 30 x 30	K 078	 52 x 10
K 057	 30 x 15	K 079	 18 x 9,5
K 064	 18,5 x 9,5	K 087	 27 x 18,5
K 065	 23,5 x 10,7	K 088	 27 x 13
K 066	 23 x 11	K 089	 25 x 12,5
K 071	 32 x 20	K 090	 38 x 22,5
K 072	 34 x 10	K 093	 30 x 11











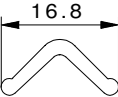
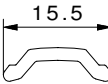

Estorfer Kunststoffbetrieb GmbH

Zum Finkenbergr 12 • 31629 Estorf

www.estorfer.de • info@estorfer.de

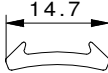
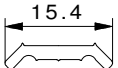
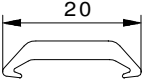
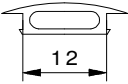
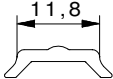
Tel 05025/9707-0 • Fax 05025/970769

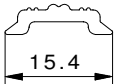
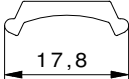
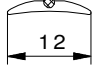
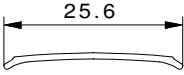
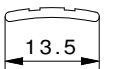
Screw - coverings

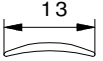
Profile no.	Drawings	Profile no.	Drawings
E 109		E 268	
E 117		E 998	
E 635		E 323	 <i>zwei- farbig</i>
E 151		E 331	
E 152		E 346	
E 648		E 350	
E 199	 <i>zwei- farbig</i>	E 396	 <i>zwei- farbig</i>
E 241		E 422	
E 245	 <i>zwei- farbig</i>	E 679	
E 246		E 979	
E 657		E 531	



Estorfer Kunststoffbetrieb GmbH

Zum Finkenbergr 12 • 31629 Estorf
www.estorfer.de • info@estorfer.de
 Tel 05025/9707-0 • Fax 05025/970769

Flat Stripes / Round Sticks / Tubes









Profile no.	Drawing	Profile no.	Drawing
E 225		E 258	
E 280		E 348	
E 443		E 632	
E640		E 817	
E 1045		E 617	
E 476		E 204	
E 253		E 134	
E 197		E 200	
E 432		E 433	 <i>(verkleinerte Darstellung)</i>
E 496		E 1241	
E 286	 <i>(verkleinerte Darstellung)</i>	E 291	 <i>(verkleinerte Darstellung)</i>

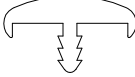

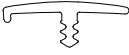
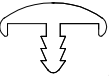
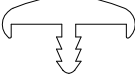
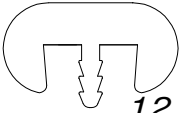
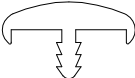
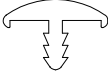
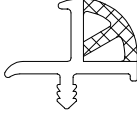
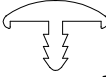
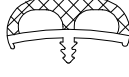
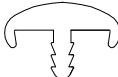
Estorfer Kunststoffbetrieb GmbH

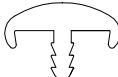
Zum Finkenbergr 12 • 31629 Estorf
www.estorfer.de • info@estorfer.de
 Tel 05025/9707-0 • Fax 05025/970769

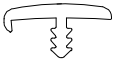
T - Section - Profiles

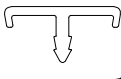
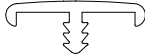
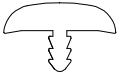
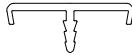





Profile no.	Drawings	Profile no.	Drawings
<i>E 10175</i>	 <i>9 mm</i>	<i>E 10121</i>	 <i>15 mm</i>
<i>E 899</i>	 <i>10 mm</i>	<i>E 605</i>	 <i>16 mm</i>
<i>E 803</i>	 <i>12 mm</i>	<i>E 771</i>	 <i>16 mm</i>
<i>E 995</i>	 <i>12,5 mm</i>	<i>E 950</i>	 <i>16 mm</i>
<i>E 770</i>	 <i>13 mm</i>	<i>E 549</i>	 <i>16 mm</i>
<i>E 10145</i>	 <i>13,5 mm</i>	<i>E 552</i>	 <i>16 mm</i>
<i>E 911</i>	 <i>13 mm</i>	<i>E 10055</i>	 <i>16 mm</i>
<i>E 949</i>	 <i>13 mm</i>	<i>E 714</i>	 <i>16 mm</i>
<i>E 835</i>	 <i>14 mm</i>	<i>E 836</i>	 <i>16 mm</i>
<i>E 165</i>	 <i>15 mm</i>	<i>E 898</i>	 <i>16 mm</i>
<i>E 1001</i>	 <i>16 mm</i>	<i>E 164</i>	 <i>17 mm</i>

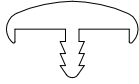
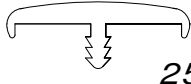

Estorfer Kunststoffbetrieb GmbH

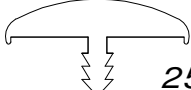
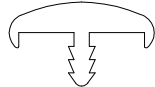
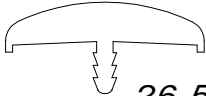
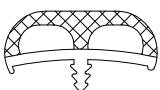
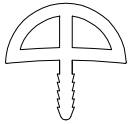
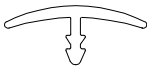
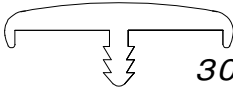
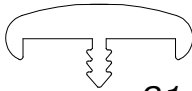
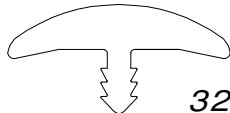
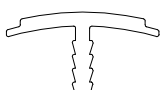
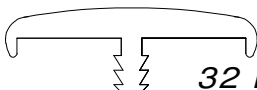
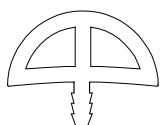
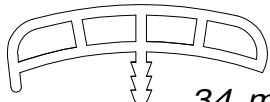
Zum Finkenbergr 12 • 31629 Estorf
www.estorfer.de • info@estorfer.de
 Tel 05025/9707-0 • Fax 05025/970769

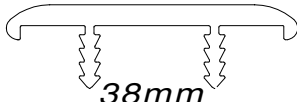
T - Section - Profiles

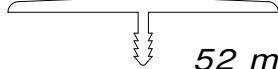
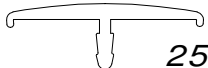
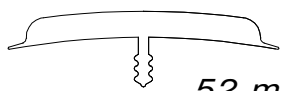



Profile no.	Drawing	Profile no.	Drawing
<i>E 10136</i>	 <i>17 mm</i>	<i>E 10137</i>	 <i>25 mm</i>
<i>E 616</i>	 <i>17 mm</i>	<i>E 876</i>	 <i>25 mm</i>
<i>E 10163</i>	 <i>18 mm</i>	<i>E 1007</i>	 <i>26,5 mm</i>
<i>E 695</i>	 <i>20 mm</i>	<i>E 668</i>	 <i>29 mm</i>
<i>E 227</i>	 <i>20 mm</i>	<i>E 779</i>	 <i>30 mm</i>
<i>E 798</i>	 <i>21,5 mm</i>	<i>E 980</i>	 <i>32 mm</i>
<i>E 231</i>	 <i>22 mm</i>	<i>E 10149</i>	 <i>32 mm</i>
<i>E 583</i>	 <i>22 mm</i>	<i>E 761</i>	 <i>34 mm</i>
<i>E 1006</i>	 <i>22,5 mm</i>	<i>E 814</i>	 <i>38mm</i>
<i>E 228</i>	 <i>25 mm</i>	<i>E 543</i>	 <i>52 mm</i>
<i>E 507</i>	 <i>25 mm</i>	<i>E 614</i>	 <i>52 mm</i>

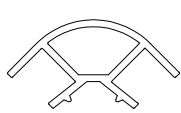
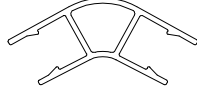
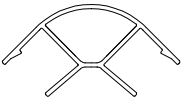
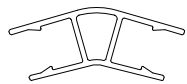
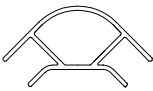
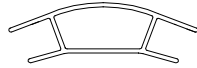
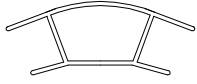

Estorfer Kunststoffbetrieb GmbH

Zum Finkenberg 12 • 31629 Estorf
www.estorfer.de • info@estorfer.de
 Tel 05025/9707-0 • Fax 05025/970769

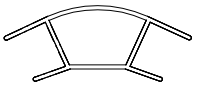
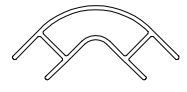
Corner - Profiles

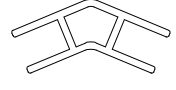
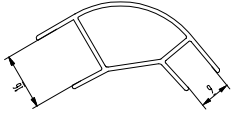
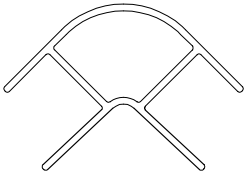
Profile no.	Drawing	Profile no.	Drawing
<i>E 665</i>	 <p style="text-align: right;">90°</p> <p style="text-align: center;"><i>Plattenstärke 13 mm</i></p>	<i>E 886</i>	 <p style="text-align: right;">122°</p> <p style="text-align: center;"><i>Plattenstärke 13 mm</i></p>
<i>E 901</i>	 <p style="text-align: right;">90°</p> <p style="text-align: center;"><i>Plattenstärke 14,5 mm</i></p>	<i>E 887</i>	 <p style="text-align: right;">148°</p> <p style="text-align: center;"><i>Plattenstärke 13 mm</i></p>
<i>E 858</i>	 <p style="text-align: right;">90°</p> <p style="text-align: center;"><i>Plattenstärke 10 mm</i></p>	<i>E 863</i>	 <p style="text-align: right;">139°</p> <p style="text-align: center;"><i>Plattenstärke 9 mm</i></p>
<i>E 755</i>	 <p style="text-align: right;">139°</p> <p style="text-align: center;"><i>Plattenstärke 13 mm</i></p>	<i>E 864</i>	 <p style="text-align: right;">131°</p> <p style="text-align: center;"><i>Plattenstärke 9 mm</i></p>
<i>E 756</i>	 <p style="text-align: right;">131°</p> <p style="text-align: center;"><i>Plattenstärke 13 mm</i></p>	<i>E 933</i>	 <p style="text-align: right;">90°</p> <p style="text-align: center;"><i>Plattenstärke 9 mm</i></p>
<i>E 894</i>	 <p style="text-align: right;">90°</p> <p style="text-align: center;"><i>Plattenstärke 6 mm</i></p>	<i>E 990</i>	 <p style="text-align: right;">135°</p> <p style="text-align: center;"><i>Plattenstärke 8 mm</i></p>
<i>E 1019</i>	 <p style="text-align: right;">100°</p> <p style="text-align: center;"><i>Plattenstärke 16 / 9 mm</i></p>	<i>E 786</i>	 <p style="text-align: right;">90°</p> <p style="text-align: center;"><i>Plattenstärke 13,5 mm</i></p>



Estorfer Kunststoffbetrieb GmbH

Zum Finkenbergr 12 • 31629 Estorf
www.estorfer.de • info@estorfer.de
 Tel 05025/9707-0 • Fax 05025/970769

Corner - Profiles / Cable - Profiles

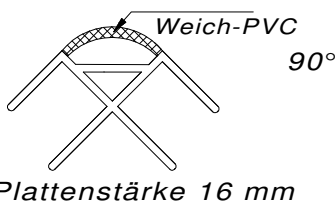
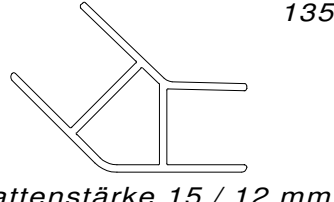
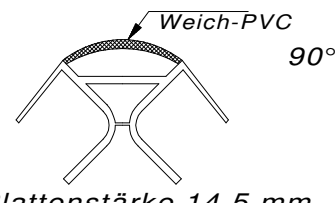
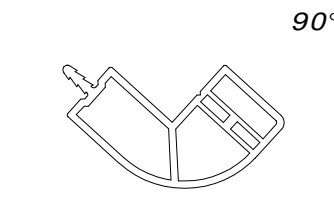
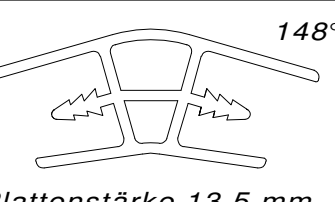
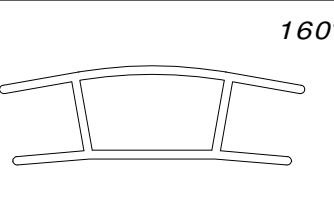
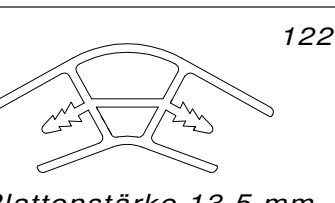
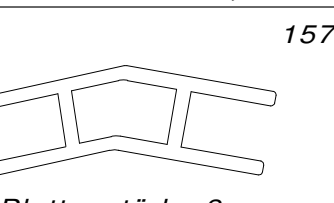
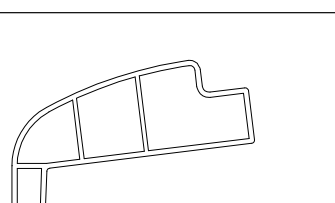
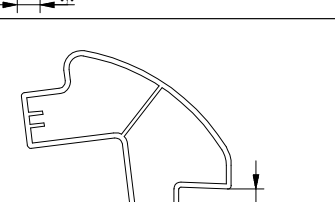
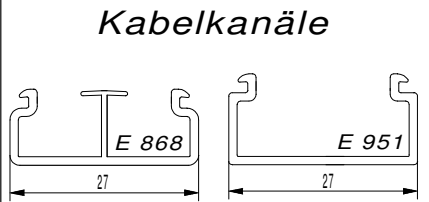
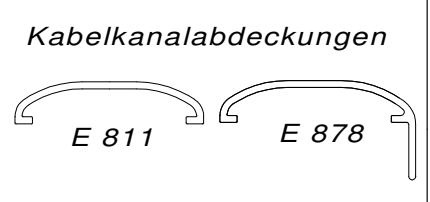







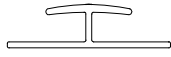

Profile no.	Drawing	Profile no.	Drawing
E 557	 <p style="text-align: right;">90°</p> <p style="text-align: center;"><i>Plattenstärke 16 mm</i></p>	E 1066	 <p style="text-align: right;">135°</p> <p style="text-align: center;"><i>Plattenstärke 15 / 12 mm</i></p>
E 622	 <p style="text-align: right;">90°</p> <p style="text-align: center;"><i>Plattenstärke 14,5 mm</i></p>	E 1090	 <p style="text-align: right;">90°</p>
E 775	 <p style="text-align: right;">148°</p> <p style="text-align: center;"><i>Plattenstärke 13,5 mm</i></p>	E 1142	 <p style="text-align: right;">160°</p> <p style="text-align: center;"><i>Plattenstärke 12,5 mm</i></p>
E 774	 <p style="text-align: right;">122°</p> <p style="text-align: center;"><i>Plattenstärke 13,5 mm</i></p>	E 1205	 <p style="text-align: right;">157°</p> <p style="text-align: center;"><i>Plattenstärke 8 mm</i></p>
E 905	 <p style="text-align: center;">6.0</p>	<p>The Corner-Profiles could be covered with Dekor-Foil or Paper-Foil</p>	
E 906	 <p style="text-align: center;">6.0</p>		
E 868 E 951	<p style="text-align: center;">Kabelkanäle</p>  <p style="text-align: center;">27 27</p>	E 811 E 878	<p style="text-align: center;"><i>Kabelkanalabdeckungen</i></p>  <p style="text-align: center;">E 811 E 878</p>

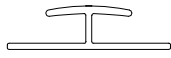
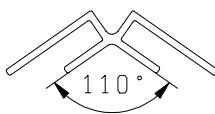
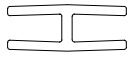
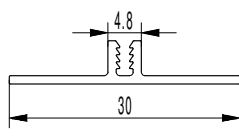

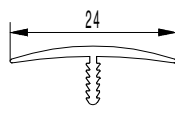
Estorfer Kunststoffbetrieb GmbH

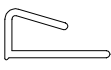
Zum Finkenbergr 12 • 31629 Estorf
www.estorfer.de • info@estorfer.de
Tel 05025/9707-0 • Fax 05025/970769

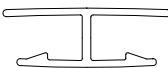
Plywood - Links

Profile no.	Drawing	Profile no.	Drawing
E 369	 Platten 4,5 mm	E 279	 Plattenstärke 5 mm
E 1117	 Platten 3mm	E 621	 Plattenstärke 3 mm
E 388	 Platten 3,2 mm	E 1109	Plattenverbinder Unterteil 
E 606	 Platten 3,2 mm	E 1110	Plattenverbinder Oberteil 
E 666	 Platten 1mm	E 554	 Plattenstärke 3 mm
E 748	 Platten 2,5mm	E 848	Plattenstärke 3 mm  LD - PE
E 895	 Platten 6mm Klipsmontage	E 733	 Plattenstärke 2,2mm



Estorfer Kunststoffbetrieb GmbH

Zum Finkenberg 12 • 31629 Estorf

www.estorfer.de • info@estorfer.de

Tel 05025/9707-0 • Fax 05025/970769

Board - Railings

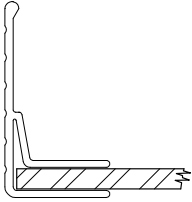
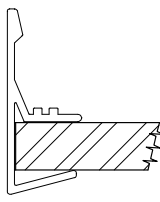
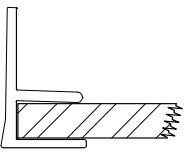
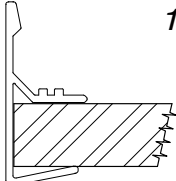
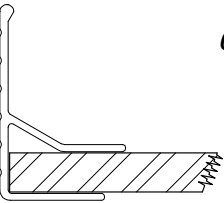
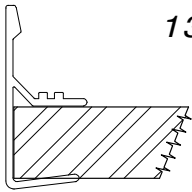
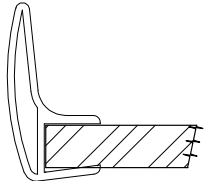
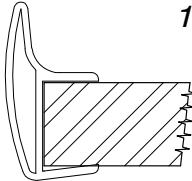
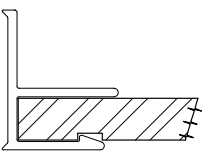
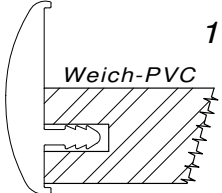
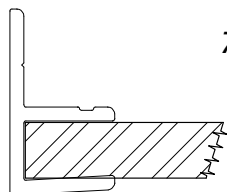
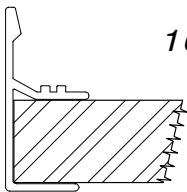
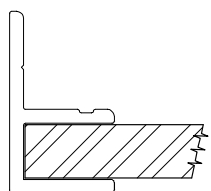
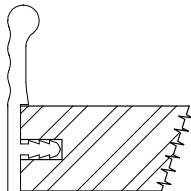
Profile no.	Drawing	Profile no.	Drawing
E 536	 3 mm	E 10207	 9 mm
E 796	 5 mm	E 10206	 12 mm
E 527	 6 mm	E 571	 13 mm
E 902	 6 mm	E 903	 13 mm
E 912	 6 mm	E 927	 13 mm Weich-PVC
E 604	 7 mm	E 10205	 16 mm
E 1098	 8 mm	E 937	



Estorfer Kunststoffbetrieb GmbH

Zum Finkenbergr 12 • 31629 Estorf
www.estorfer.de • info@estorfer.de
 Tel 05025/9707-0 • Fax 05025/970769

Joint - Coverings

Profile no.	Drawing	Profile no.	Drawing
<i>E 128</i>		<i>E 692</i>	
<i>E 207</i>		<i>E 511</i>	
<i>E 210</i>		<i>E 1144</i>	
<i>E 263</i>		<i>E 535</i>	
<i>E 298</i>		<i>E 522</i>	
<i>E 559</i>		<i>E 430</i>	
<i>E 703</i>		<i>E 1061</i>	
<i>E 717</i>		<i>E 1229</i>	
<i>E 977</i>		<i>E 791</i>	
<i>E 831</i>		<i>E 295</i>	
<i>E 939</i>		<i>E 313</i>	



Estorfer Kunststoffbetrieb GmbH

Zum Finkenbergr 12 • 31629 Estorf
www.estorfer.de • info@estorfer.de
 Tel 05025/9707-0 • Fax 05025/970769

Washers - Profiles

Profile no.	Drawing	Profile no.	Drawing
<i>E 122</i>		<i>E 532</i>	
<i>E 166</i>		<i>E 629</i>	
<i>E 169</i>		<i>E 630</i>	
<i>E 198</i>		<i>E 672</i>	
<i>E 202</i>		<i>E 694</i>	
<i>E 223</i>		<i>E 919</i>	
<i>E 322</i>		<i>E 183</i>	
<i>E 324</i>		<i>E 481</i>	
<i>E 335</i>		<i>E 867</i>	
<i>E 347</i>		<i>E 896</i>	
<i>E 509</i>		<i>E 1088</i>	



Estorfer Kunststoffbetrieb GmbH

Zum Finkenbergr 12 • 31629 Estorf

www.estorfer.de • info@estorfer.de

Tel 05025/9707-0 • Fax 05025/970769

